

# DNSODM200\_ RLDRAM

DDR2 SODIMM form factor  
2 RLDRAM (32 bit) 2Mb x 32  
300Mhz Max  
?Mhz Min

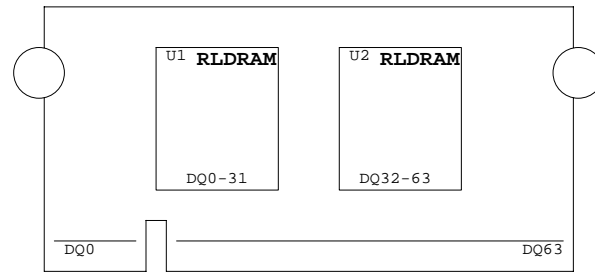

Drawn	<b>The Dini Group</b> La Jolla, inc.	Project	sram_mod (RLDRAM)
Approved	<small>The information disclosed herein was originated by and is the property of The Dini Group. The Dini Group reserves all patent, proprietary, design manufacturing, reproduction, use and sale rights thereto, and to any article disclosed therein.</small>	Page Desc	COVER PAGE
		Document Number	Sheet
		501_0133_0005_01	1 Of 2
		Rev	Tuesday, March 07, 2006
		1	

713mA 1.8  
50mA 2.5

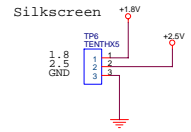
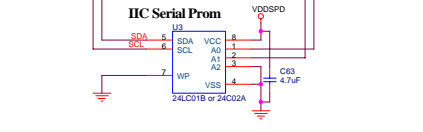
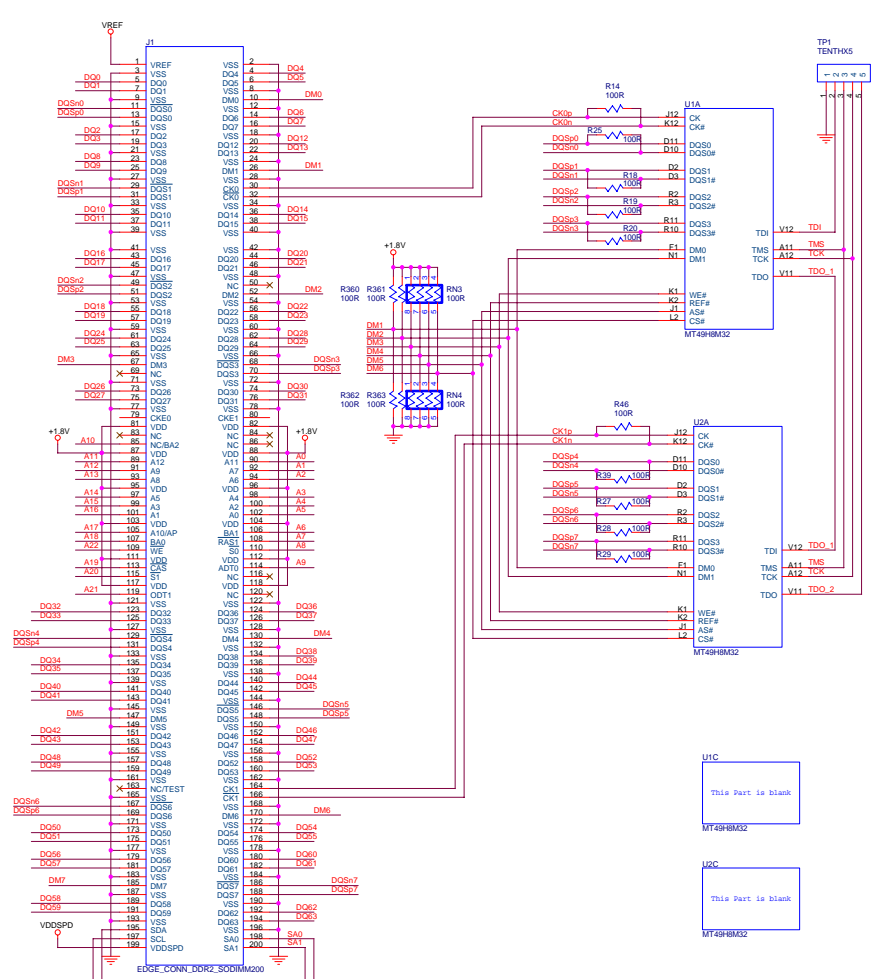
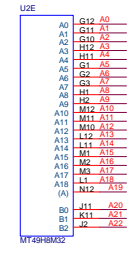
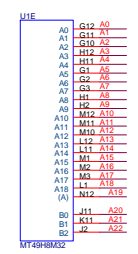
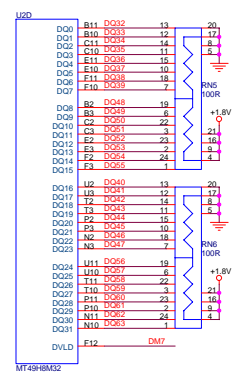
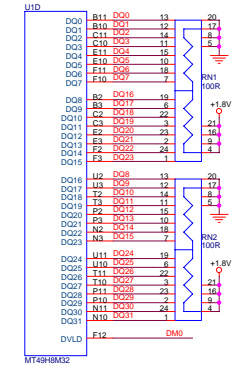
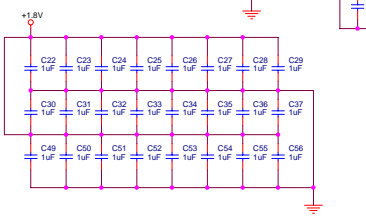
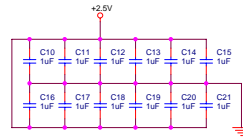
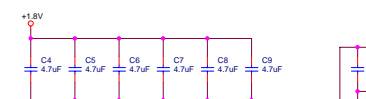
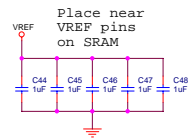
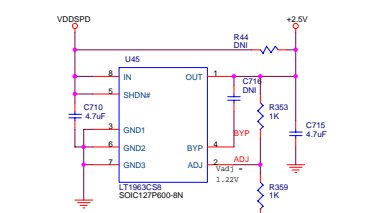
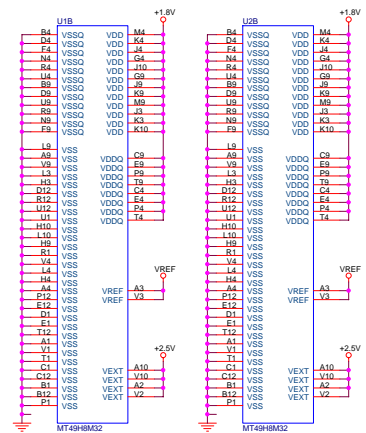

Drawn	The Dini Group La Jolla, inc.	Project	sram_mod (RLDRAM)
Approved	The information disclosed herein was originated by and is the property of The Dini Group. The Dini Group reserves all patent, proprietary, design manufacturing, reproduction, use and sale rights thereto, and to any article disclosed therein.	Page Desc	Some stuff on it page ok
		Document Number	501_233_0035_01
		Sheet	2 Of 2
		Rev	Tuesday, March 07, 2006